

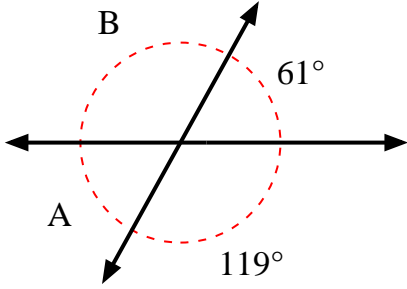

Find the value of angle 'A' and angle 'B'.

1)



2)

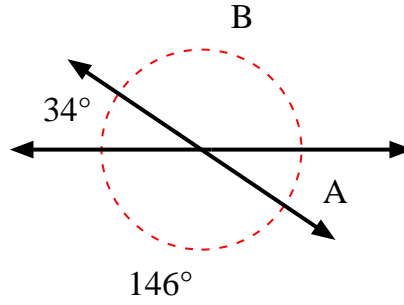

3)

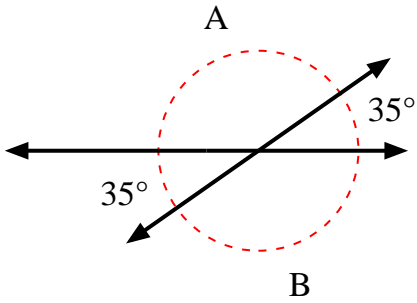

4)

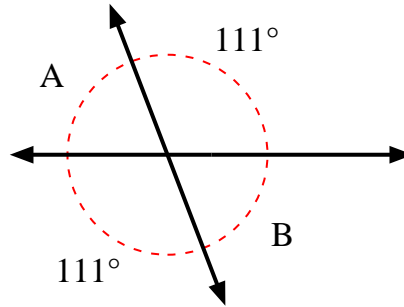

5)

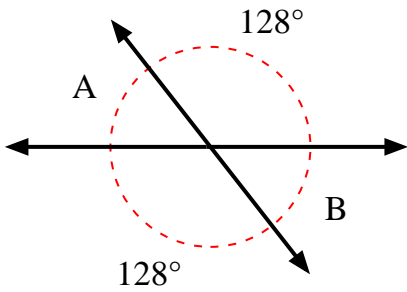

6)

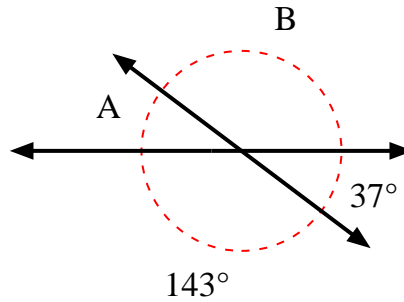

7)

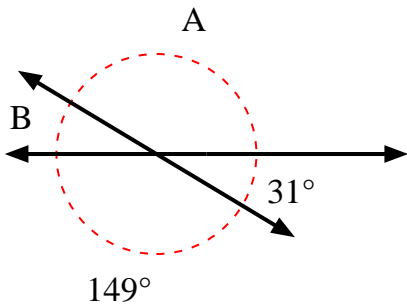

8)

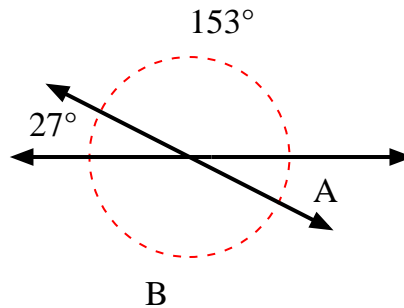

Answers

1. \_\_\_\_\_
2. \_\_\_\_\_
3. \_\_\_\_\_
4. \_\_\_\_\_
5. \_\_\_\_\_
6. \_\_\_\_\_
7. \_\_\_\_\_
8. \_\_\_\_\_



Find the value of angle 'A' and angle 'B'.

1)

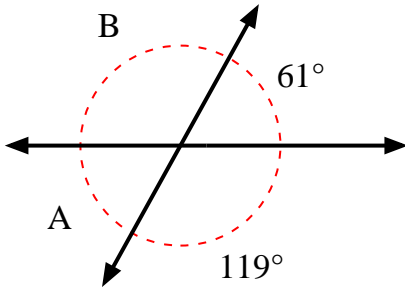

2)

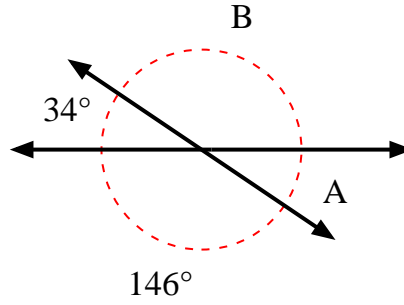

3)

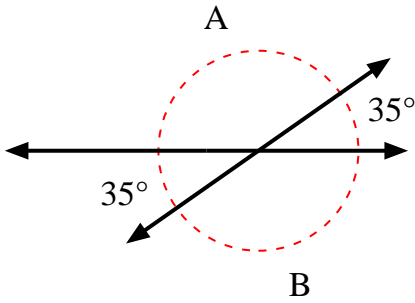

4)

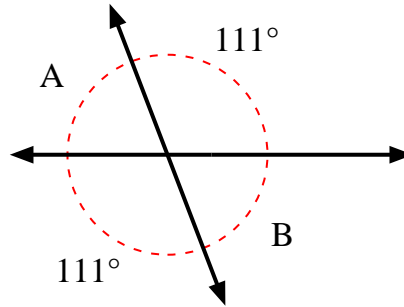

5)

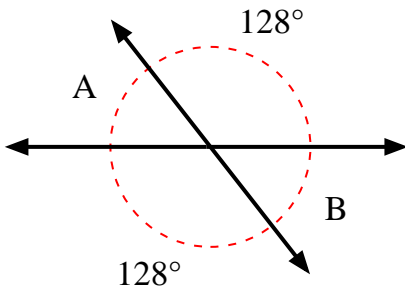

6)

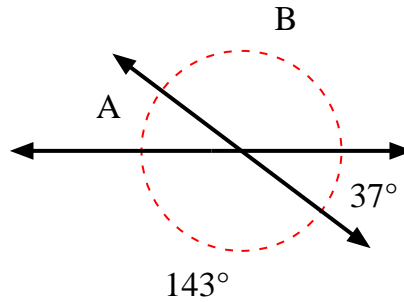

7)

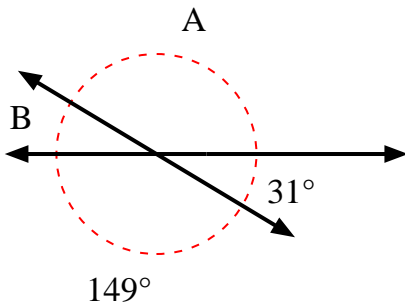

8)

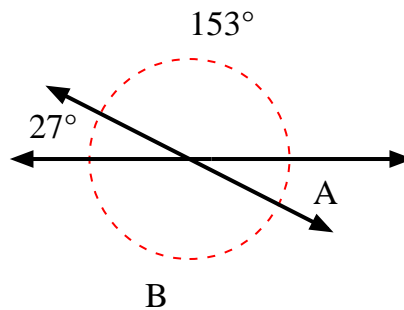

Answers

1. 61° 119°
2. 34° 146°
3. 145° 145°
4. 69° 69°
5. 52° 52°
6. 37° 143°
7. 149° 31°
8. 27° 153°



Find the value of angle 'A' and angle 'B'.

1)

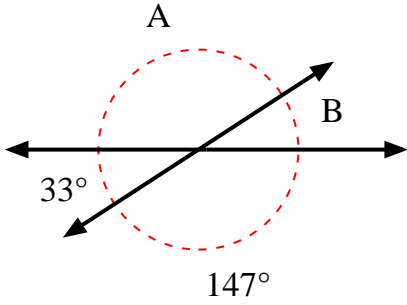

2)

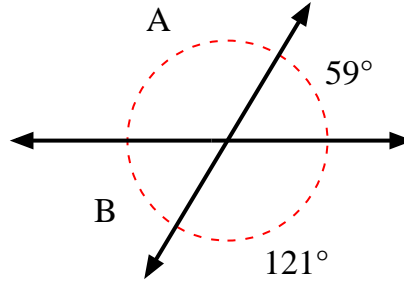

3)

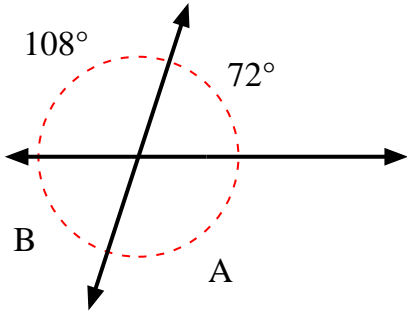

4)

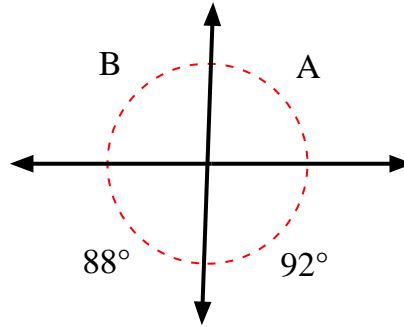

5)

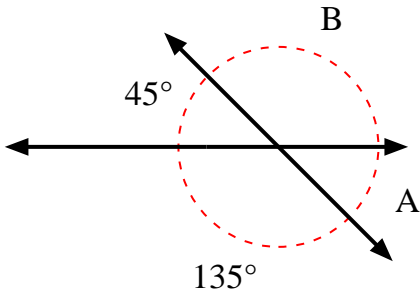

6)

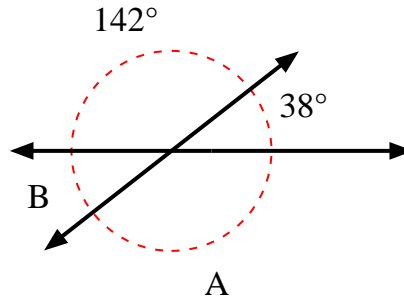

7)

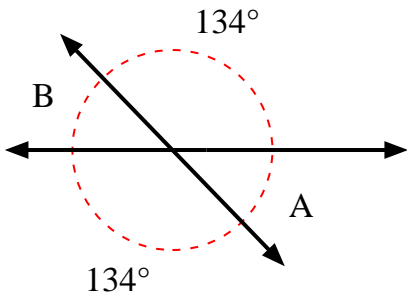

8)

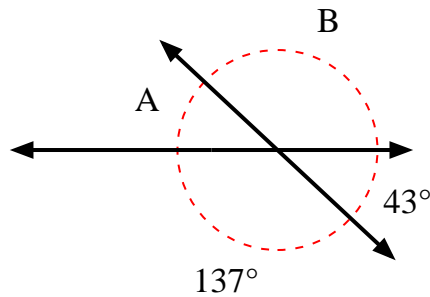

Answers

1. \_\_\_\_\_
2. \_\_\_\_\_
3. \_\_\_\_\_
4. \_\_\_\_\_
5. \_\_\_\_\_
6. \_\_\_\_\_
7. \_\_\_\_\_
8. \_\_\_\_\_



Find the value of angle 'A' and angle 'B'.

1)

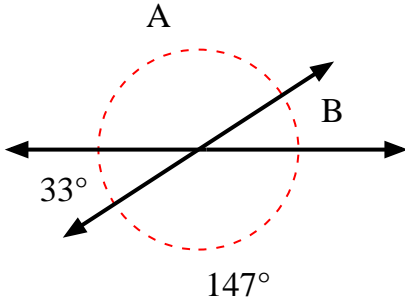

2)

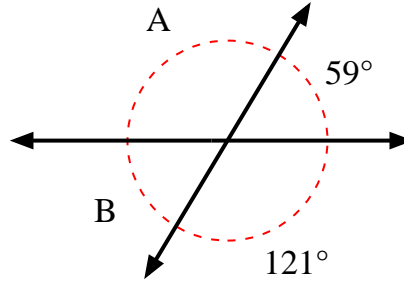

3)

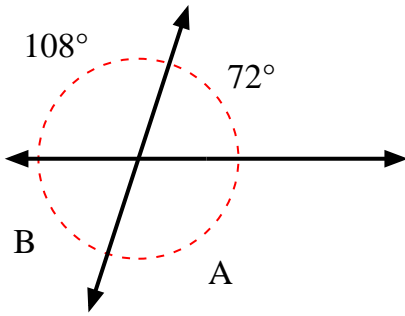

4)

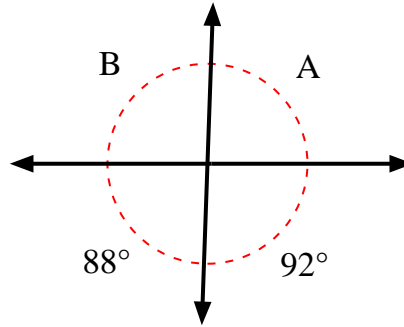

5)

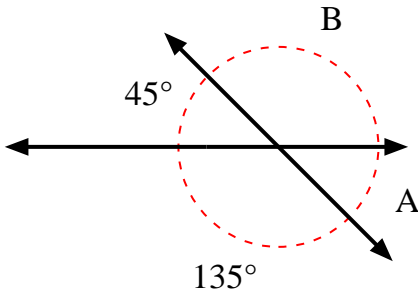

6)

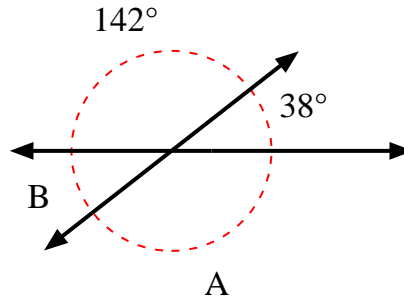

7)

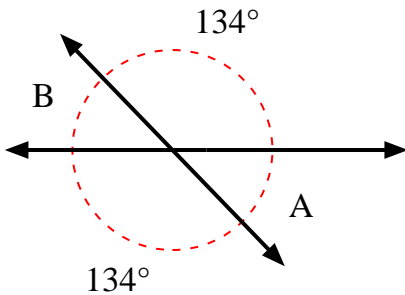

8)

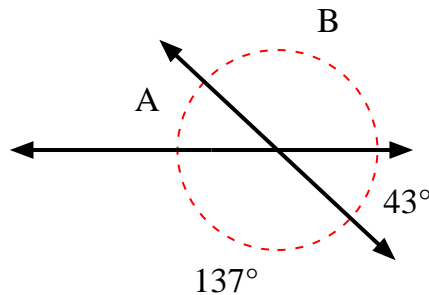

Answers

1. 147°    33°
2. 121°    59°
3. 108°    72°
4. 88°    92°
5. 45°    135°
6. 142°    38°
7. 46°    46°
8. 43°    137°



Find the value of angle 'A' and angle 'B'.

1)

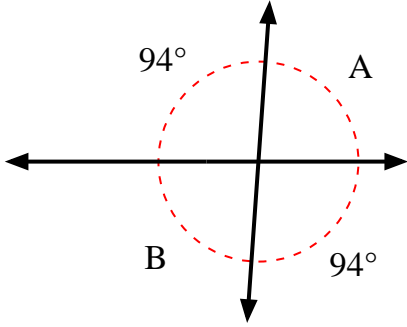

2)

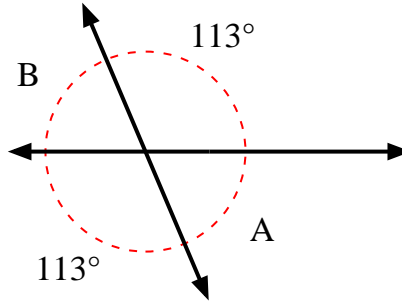

3)

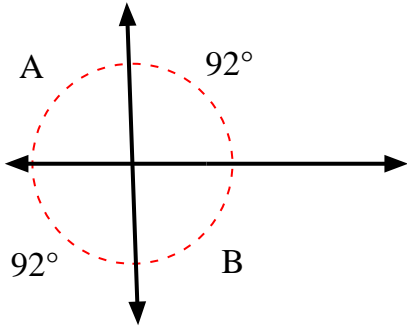

4)

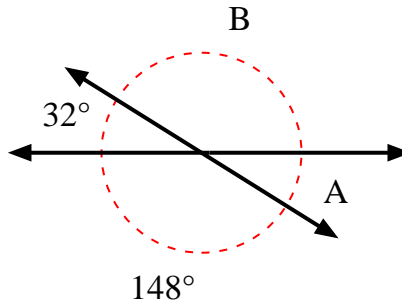

5)

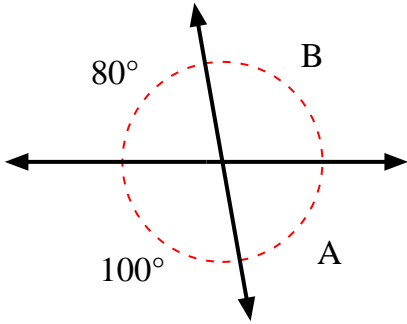

6)

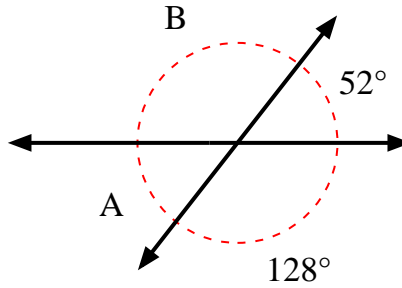

7)

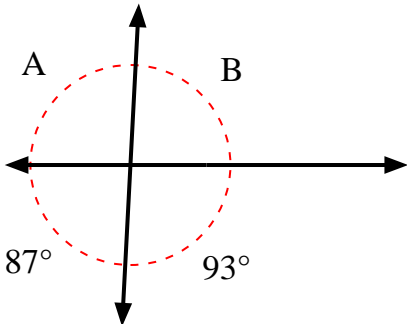

8)

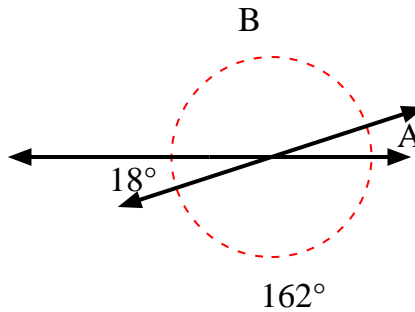

Answers

1. \_\_\_\_\_
2. \_\_\_\_\_
3. \_\_\_\_\_
4. \_\_\_\_\_
5. \_\_\_\_\_
6. \_\_\_\_\_
7. \_\_\_\_\_
8. \_\_\_\_\_



Find the value of angle 'A' and angle 'B'.

1)

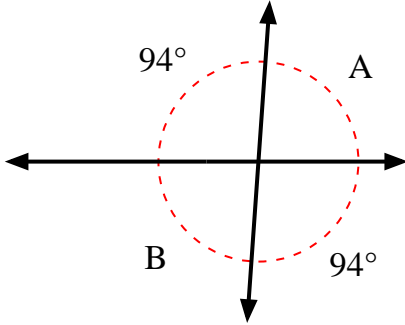

2)

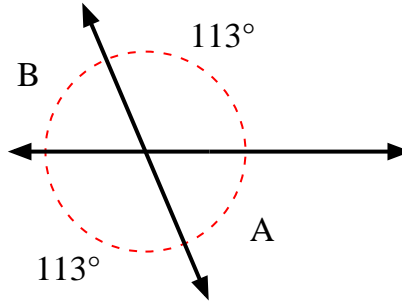

3)

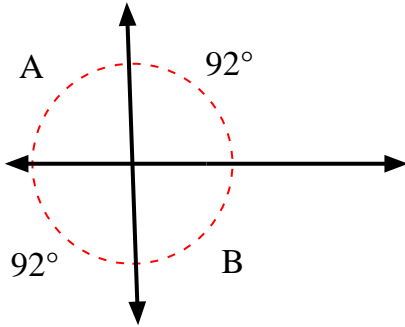

4)

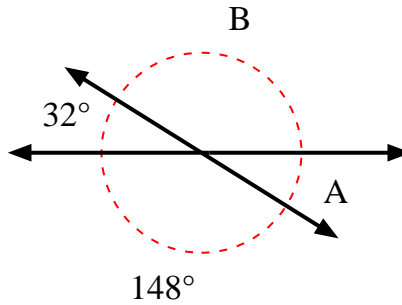

5)

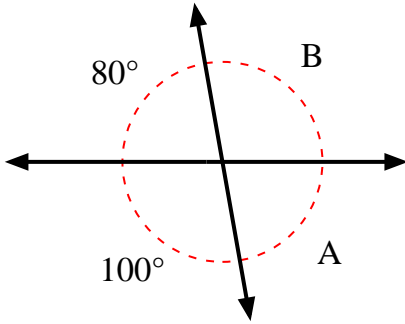

6)

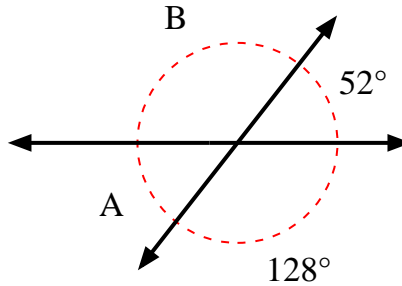

7)

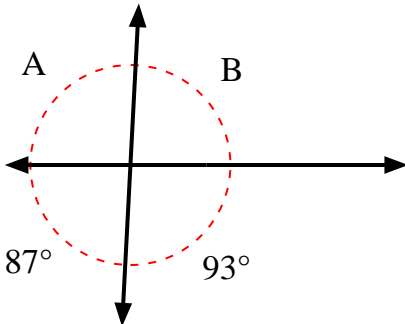

8)

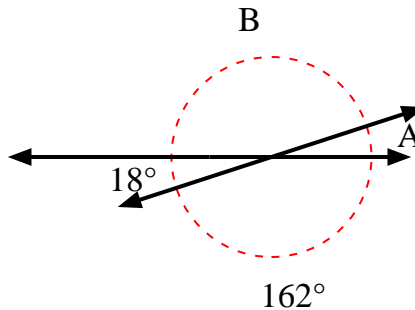

Answers

1. 86°    86°
2. 67°    67°
3. 88°    88°
4. 32°    148°
5. 80°    100°
6. 52°    128°
7. 93°    87°
8. 18°    162°



Find the value of angle 'A' and angle 'B'.

1)

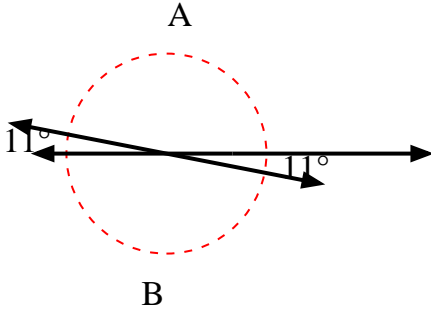

2)

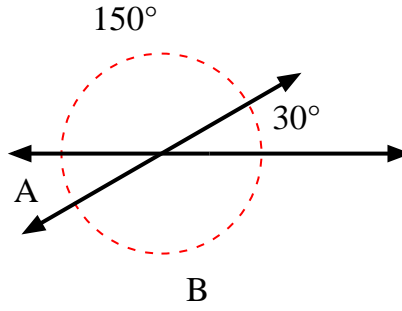

3)

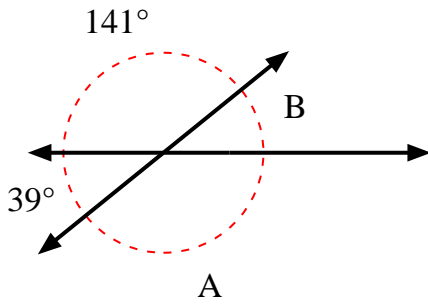

4)

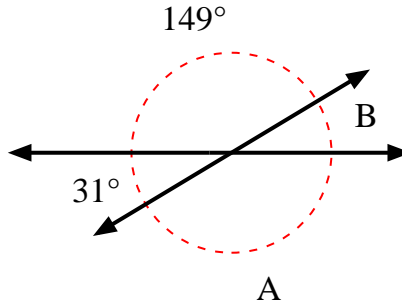

5)

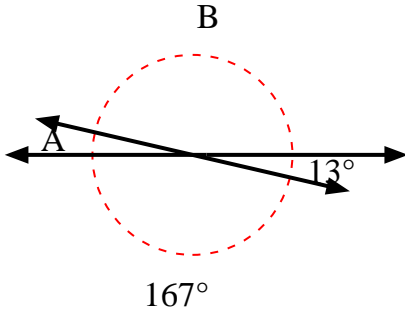

6)

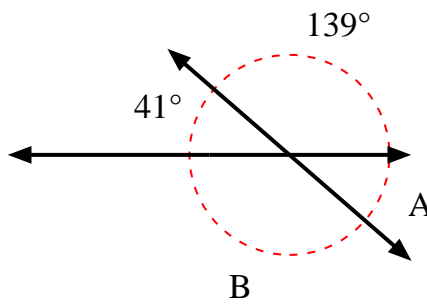

7)

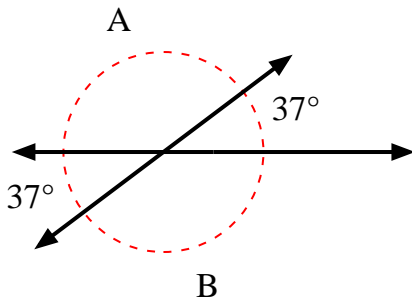

8)

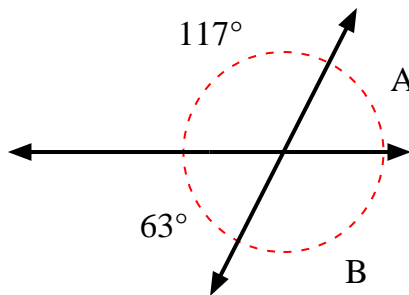

Answers

1. \_\_\_\_\_
2. \_\_\_\_\_
3. \_\_\_\_\_
4. \_\_\_\_\_
5. \_\_\_\_\_
6. \_\_\_\_\_
7. \_\_\_\_\_
8. \_\_\_\_\_



Find the value of angle 'A' and angle 'B'.

1)

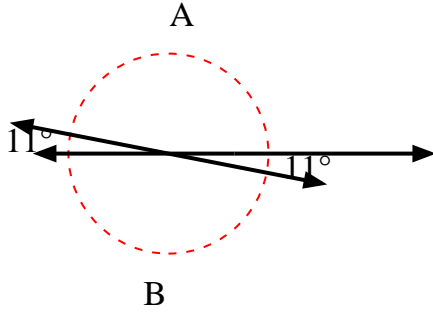

2)

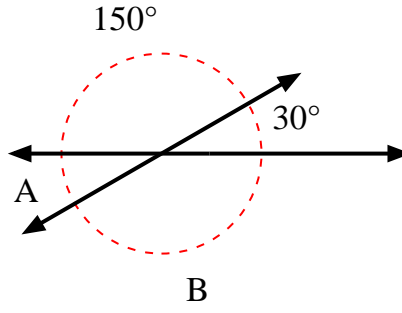

3)

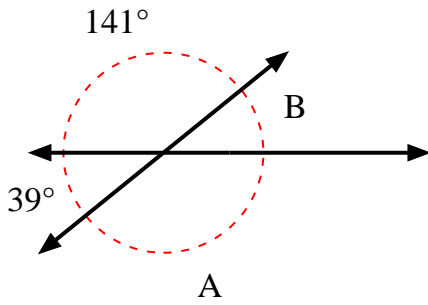

4)

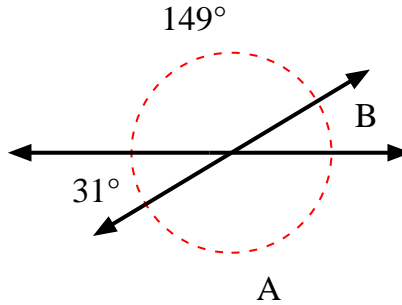

5)

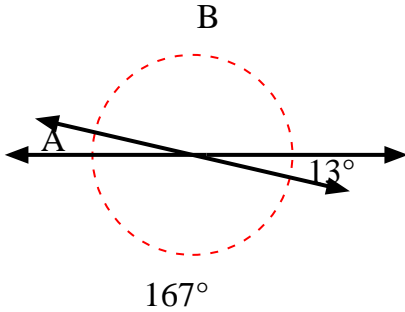

6)

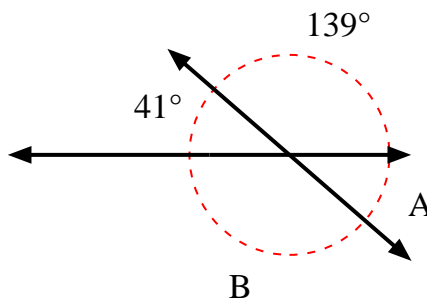

7)

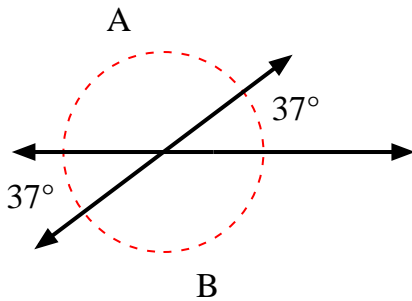

8)

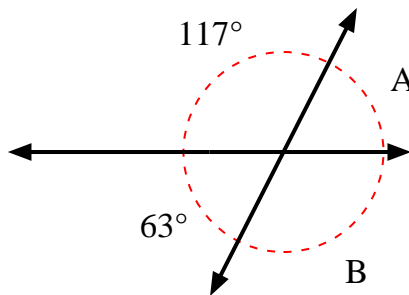

Answers

1. 169° 169°
2. 30° 150°
3. 141° 39°
4. 149° 31°
5. 13° 167°
6. 41° 139°
7. 143° 143°
8. 63° 117°





Find the value of angle 'A' and angle 'B'.

1)

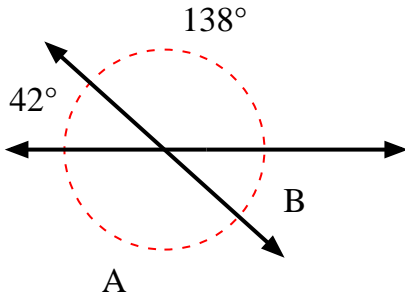

2)

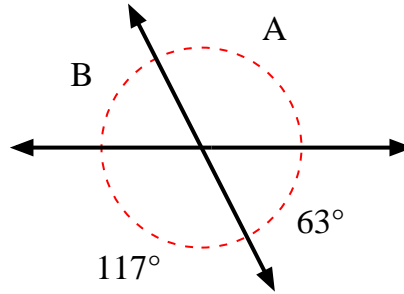

3)

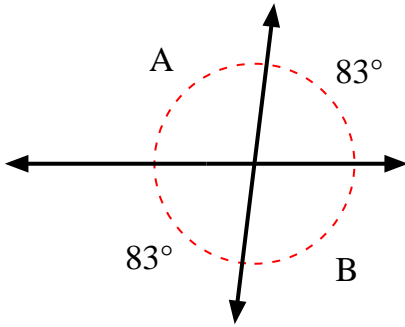

4)

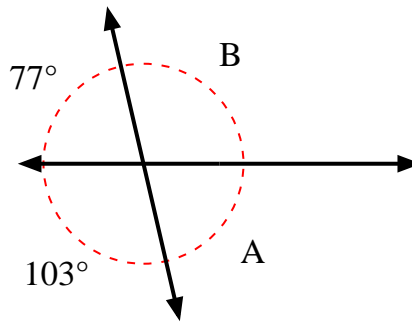

5)

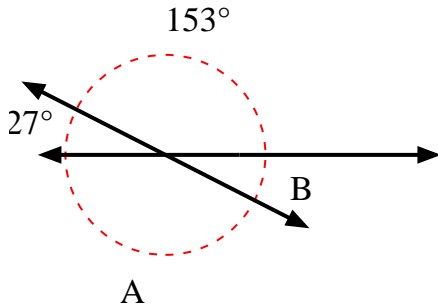

6)

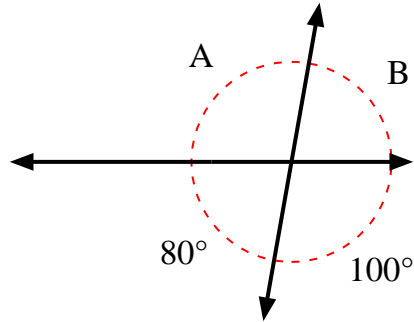

7)

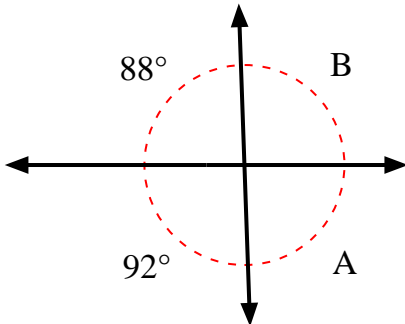

8)

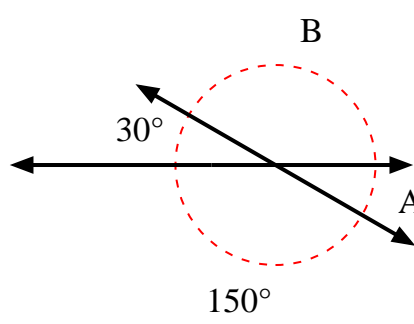

Answers

1. \_\_\_\_\_
2. \_\_\_\_\_
3. \_\_\_\_\_
4. \_\_\_\_\_
5. \_\_\_\_\_
6. \_\_\_\_\_
7. \_\_\_\_\_
8. \_\_\_\_\_



Find the value of angle 'A' and angle 'B'.

1)

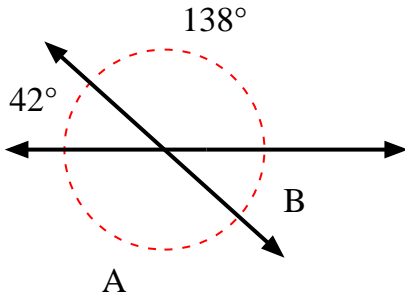

2)

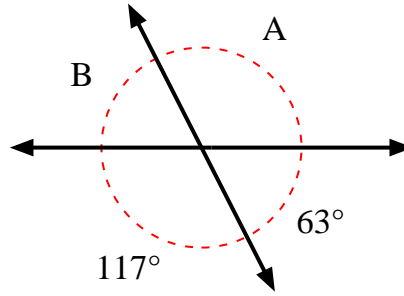

3)

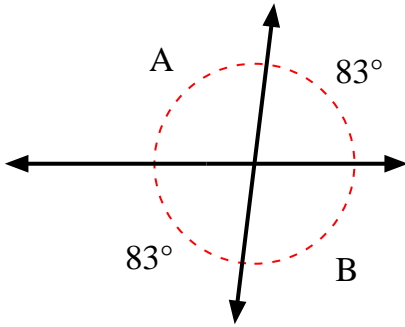

4)

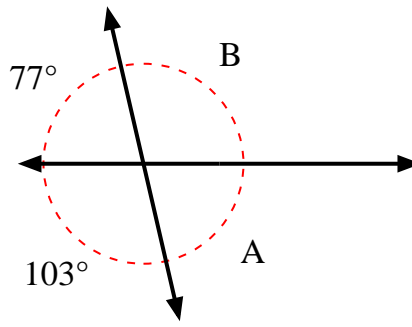

5)

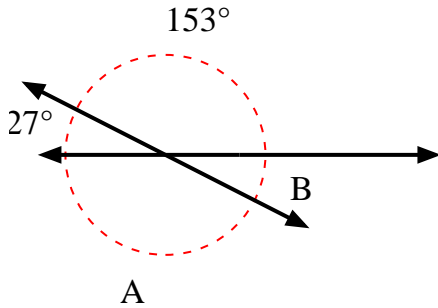

6)

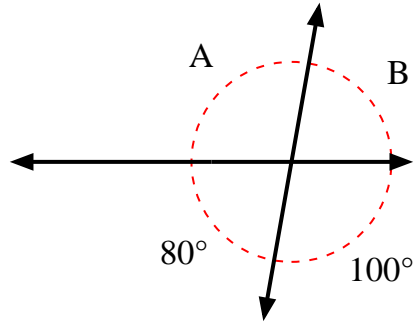

7)

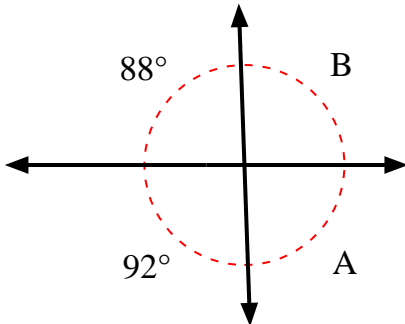

8)

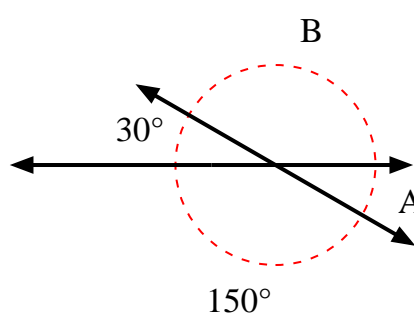

Answers

1. 138°    42°
2. 117°    63°
3. 97°    97°
4. 77°    103°
5. 153°    27°
6. 100°    80°
7. 88°    92°
8. 30°    150°



Find the value of angle 'A' and angle 'B'.

1)

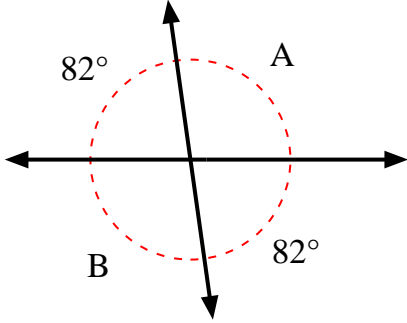

2)

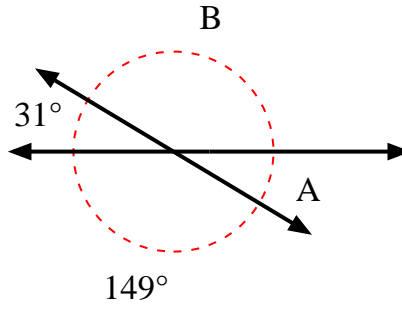

3)

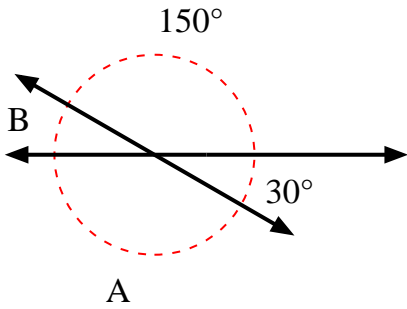

4)

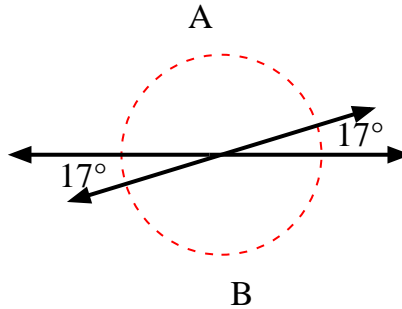

5)

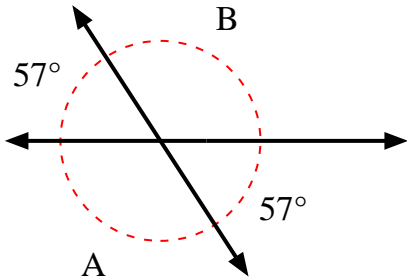

6)

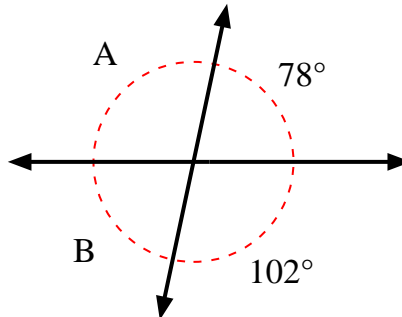

7)

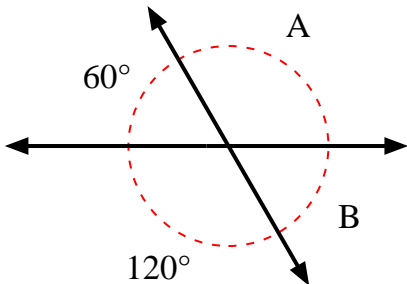

8)

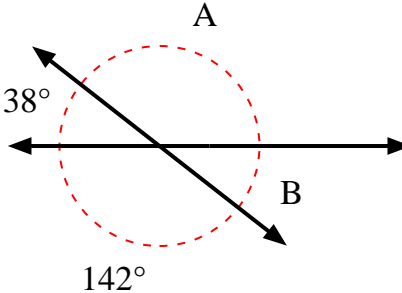

Answers

1. \_\_\_\_\_
2. \_\_\_\_\_
3. \_\_\_\_\_
4. \_\_\_\_\_
5. \_\_\_\_\_
6. \_\_\_\_\_
7. \_\_\_\_\_
8. \_\_\_\_\_



Find the value of angle 'A' and angle 'B'.

1)

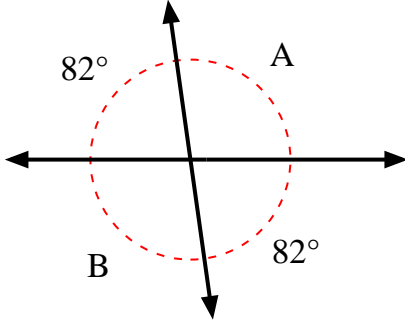

2)

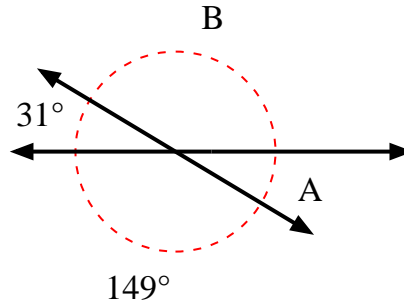

3)

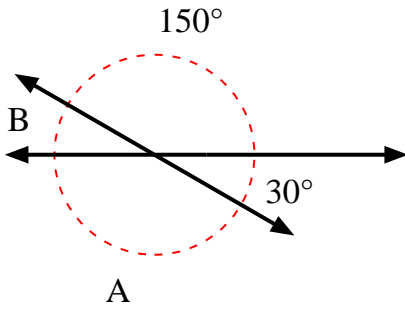

4)

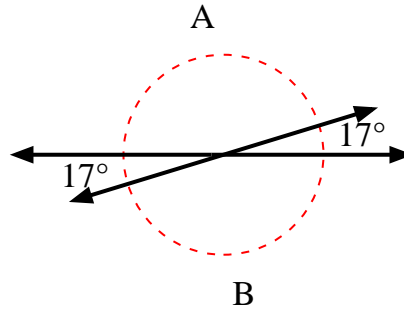

5)

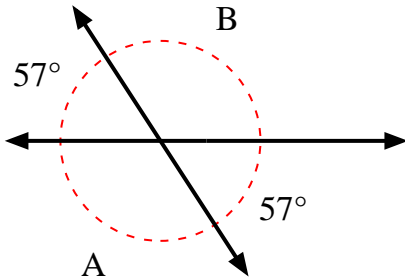

6)

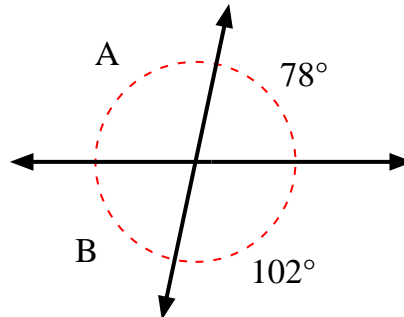

7)

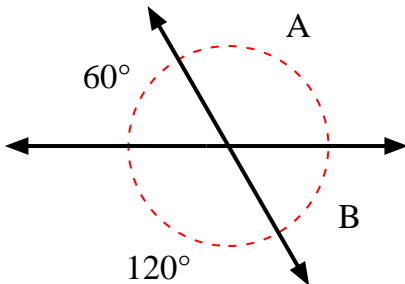

8)

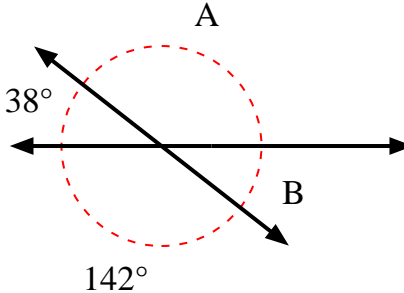

Answers

1. 98°    98°
2. 31°    149°
3. 150°    30°
4. 163°    163°
5. 123°    123°
6. 102°    78°
7. 120°    60°
8. 142°    38°



Find the value of angle 'A' and angle 'B'.

1)

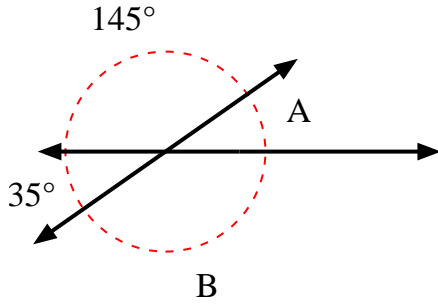

2)

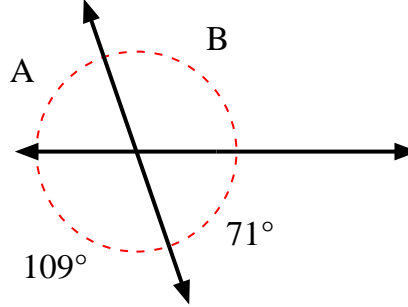

3)

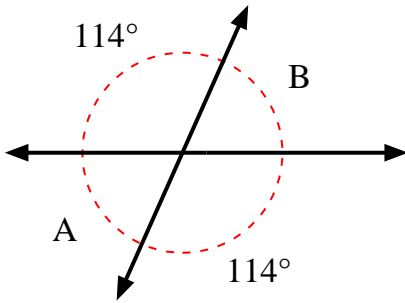

4)

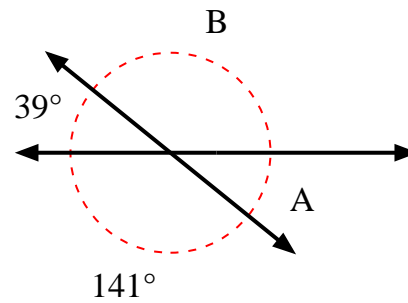

5)

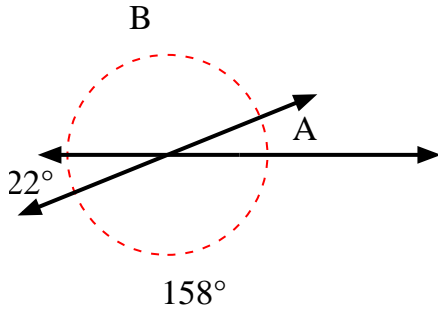

6)

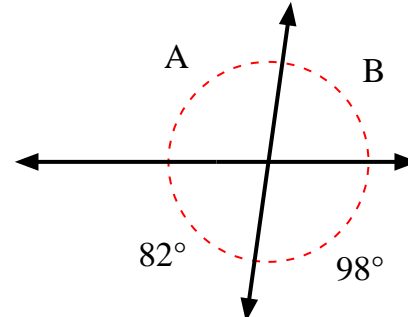

7)

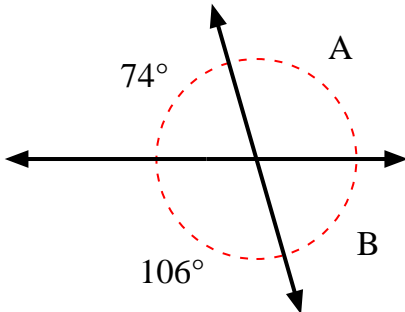

8)

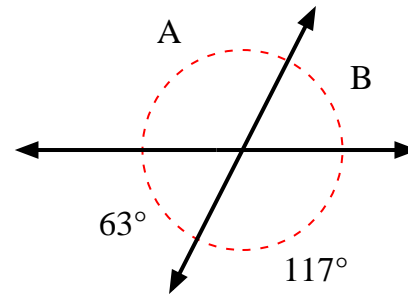

Answers

1. \_\_\_\_\_
2. \_\_\_\_\_
3. \_\_\_\_\_
4. \_\_\_\_\_
5. \_\_\_\_\_
6. \_\_\_\_\_
7. \_\_\_\_\_
8. \_\_\_\_\_



Find the value of angle 'A' and angle 'B'.

1)

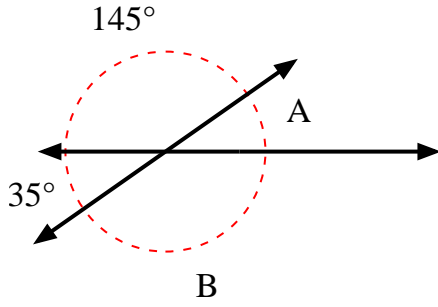

2)

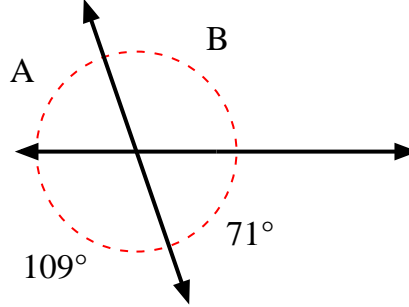

3)

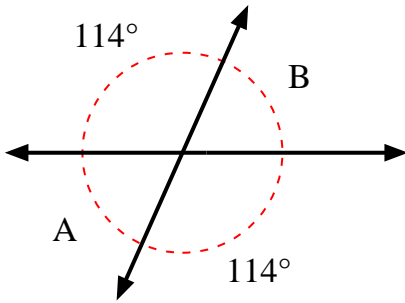

4)

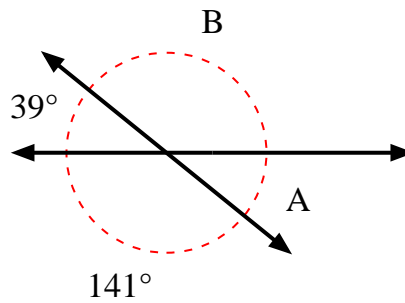

5)

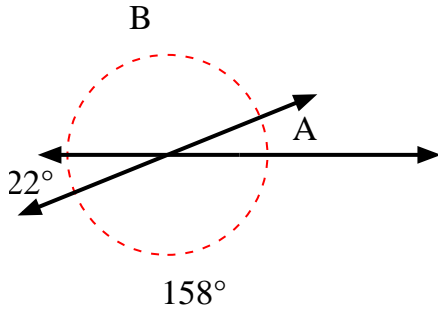

6)

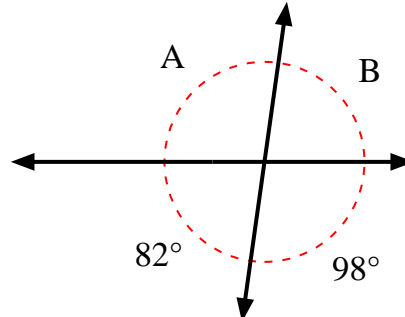

7)

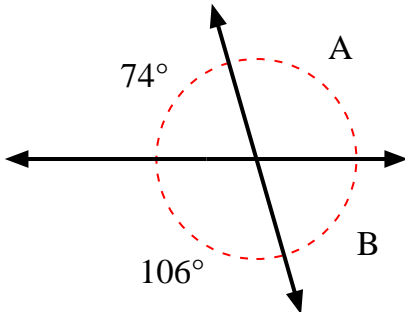

8)

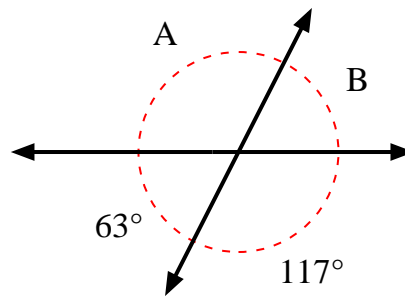

Answers

1. 35°    145°
2. 71°    109°
3. 66°    66°
4. 39°    141°
5. 22°    158°
6. 98°    82°
7. 106°    74°
8. 117°    63°



Find the value of angle 'A' and angle 'B'.

1)

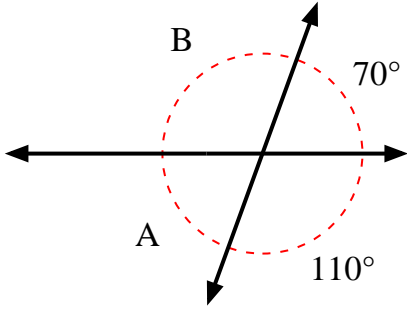

2)

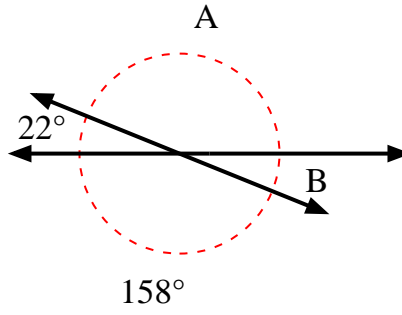

3)

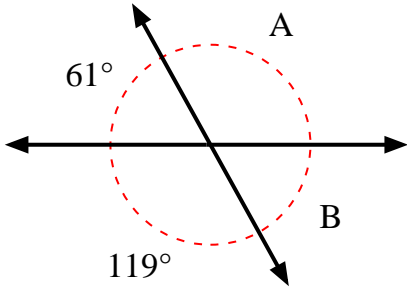

4)

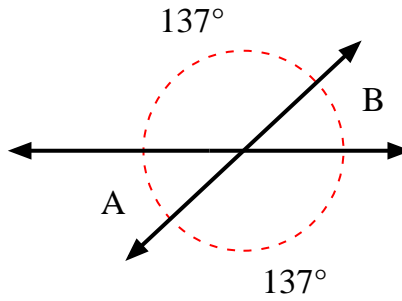

5)

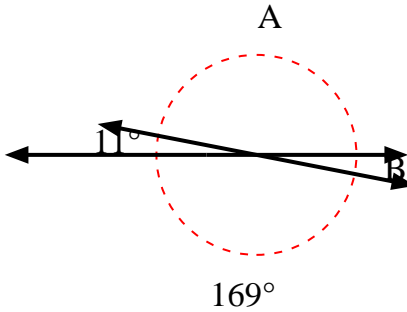

6)

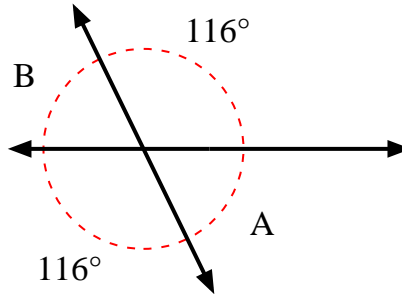

7)

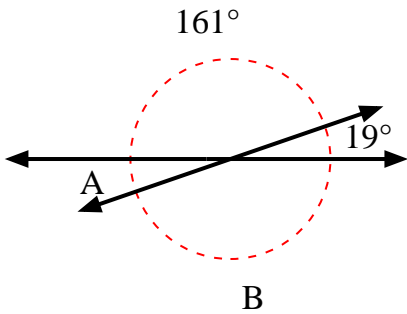

8)

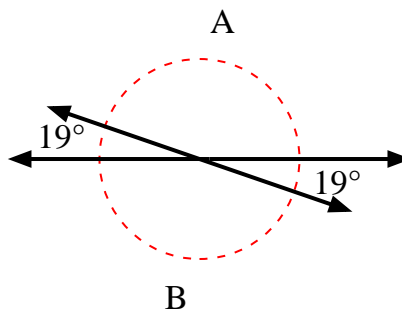

Answers

1. \_\_\_\_\_
2. \_\_\_\_\_
3. \_\_\_\_\_
4. \_\_\_\_\_
5. \_\_\_\_\_
6. \_\_\_\_\_
7. \_\_\_\_\_
8. \_\_\_\_\_



Find the value of angle 'A' and angle 'B'.

1)

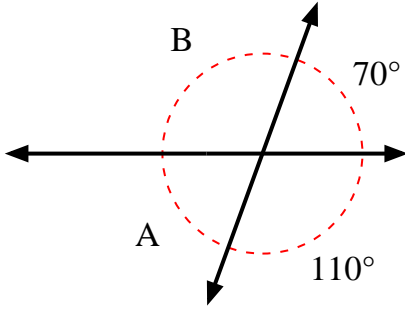

2)

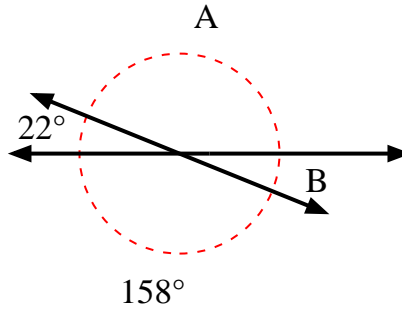

3)

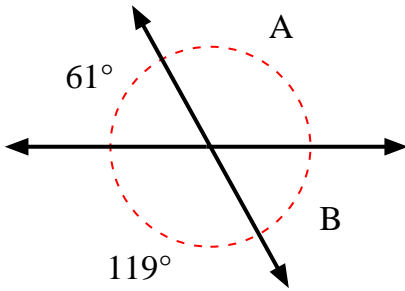

4)

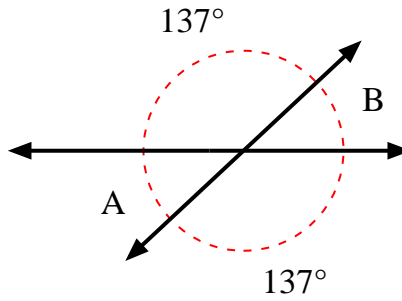

5)

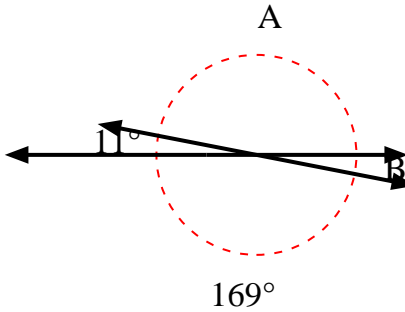

6)

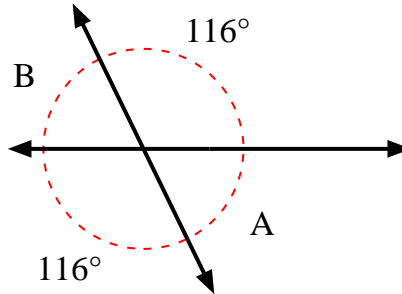

7)

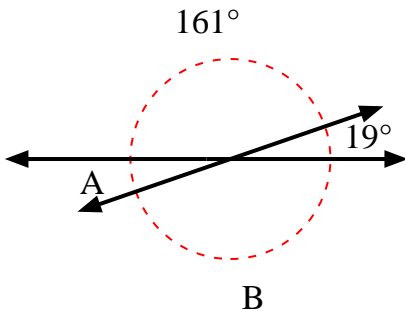

8)

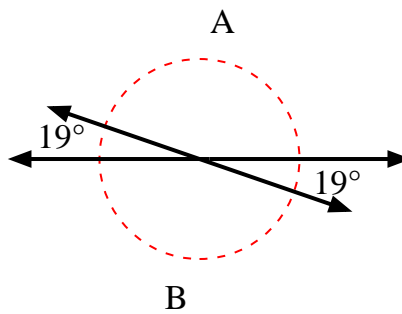

Answers

1. 70° 110°
2. 158° 22°
3. 119° 61°
4. 43° 43°
5. 169° 11°
6. 64° 64°
7. 19° 161°
8. 161° 161°





Find the value of angle 'A' and angle 'B'.

1)

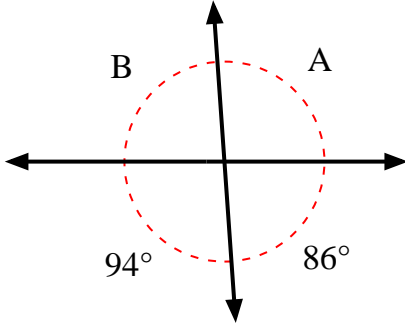

2)

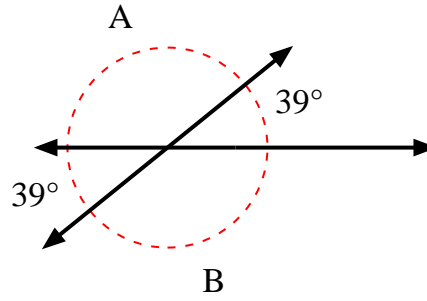

3)

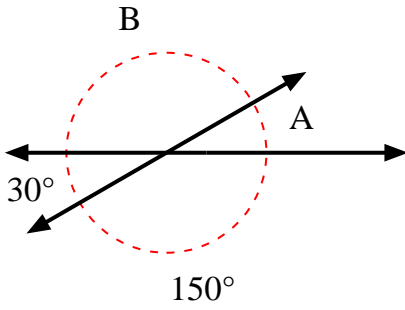

4)

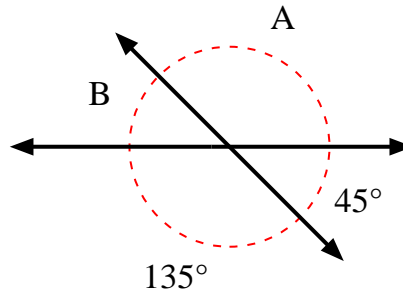

5)

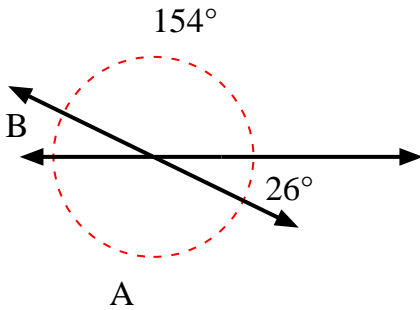

6)

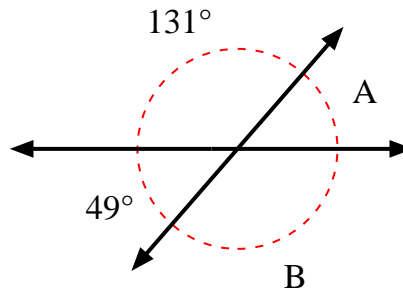

7)

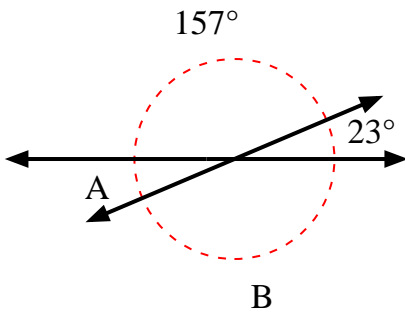

8)

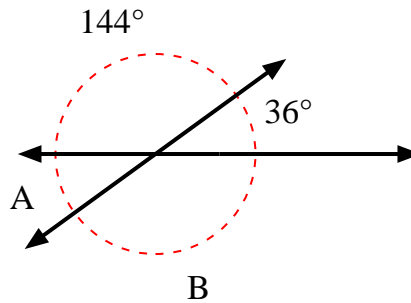

Answers

1. \_\_\_\_\_
2. \_\_\_\_\_
3. \_\_\_\_\_
4. \_\_\_\_\_
5. \_\_\_\_\_
6. \_\_\_\_\_
7. \_\_\_\_\_
8. \_\_\_\_\_



Find the value of angle 'A' and angle 'B'.

1)

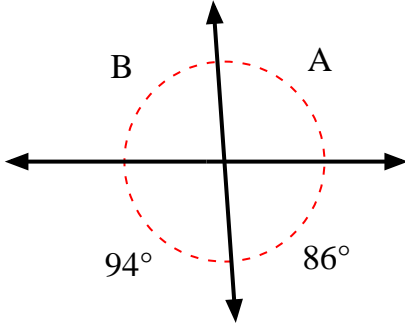

2)

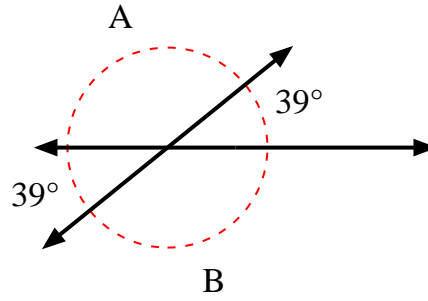

3)

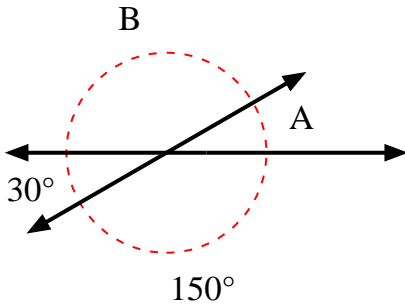

4)

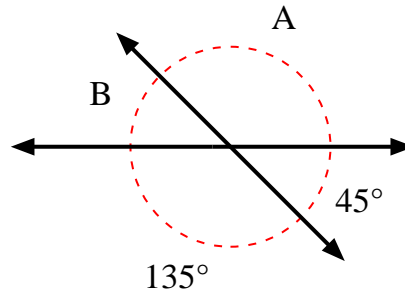

5)

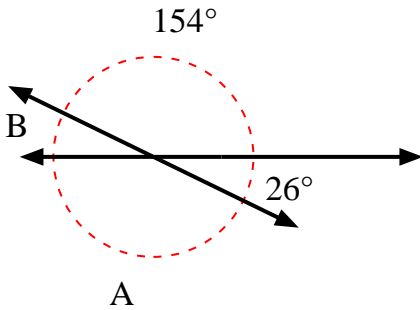

6)

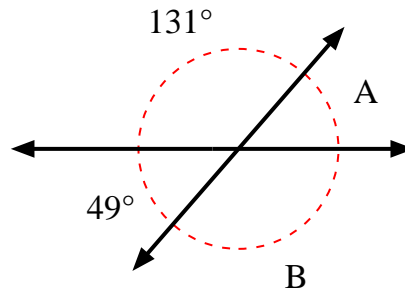

7)

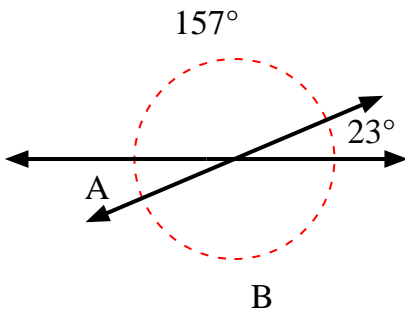

8)

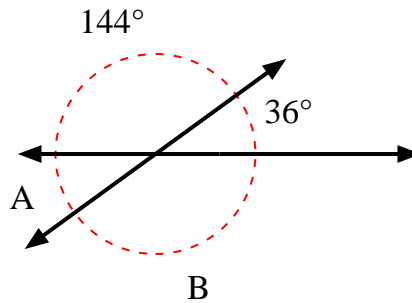

Answers

1. 94°    86°
2. 141°    141°
3. 30°    150°
4. 135°    45°
5. 154°    26°
6. 49°    131°
7. 23°    157°
8. 36°    144°



Find the value of angle 'A' and angle 'B'.

1)

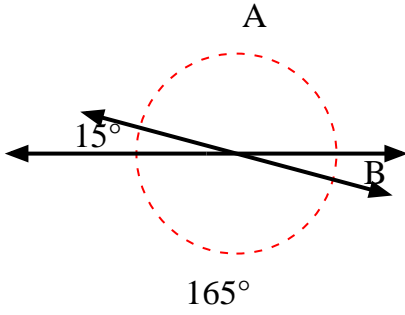

2)

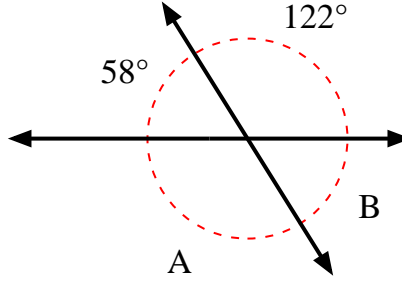

3)

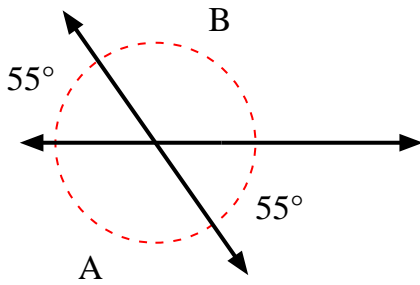

4)

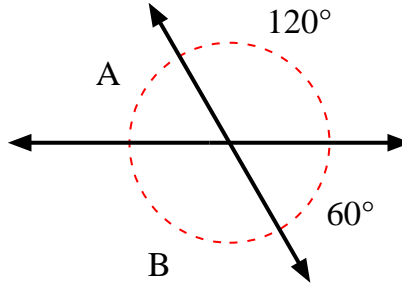

5)

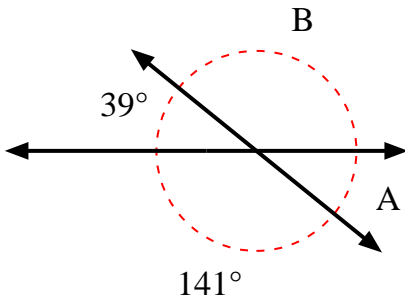

6)

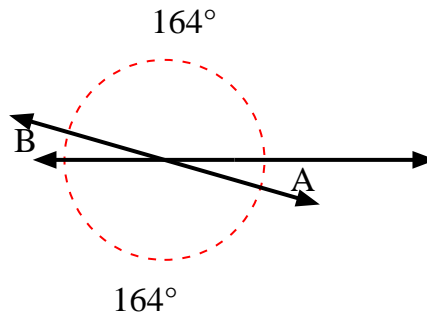

7)

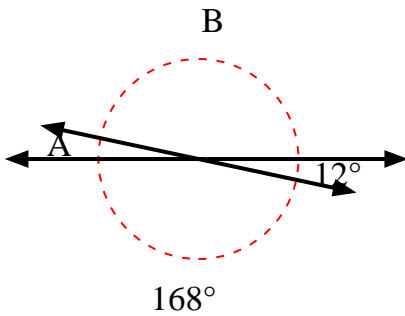

8)

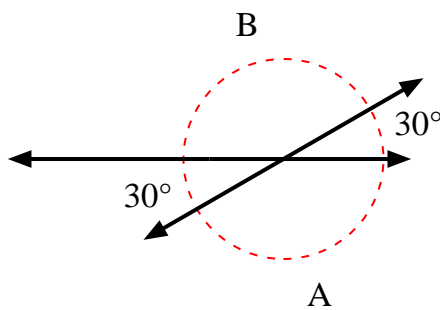

Answers

1. \_\_\_\_\_
2. \_\_\_\_\_
3. \_\_\_\_\_
4. \_\_\_\_\_
5. \_\_\_\_\_
6. \_\_\_\_\_
7. \_\_\_\_\_
8. \_\_\_\_\_



Find the value of angle 'A' and angle 'B'.

1)

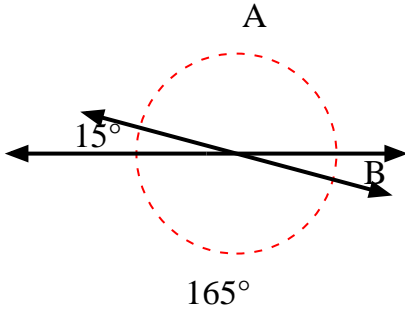

2)

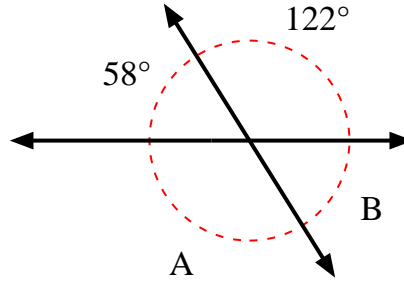

3)

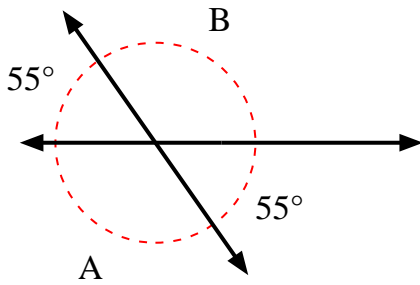

4)

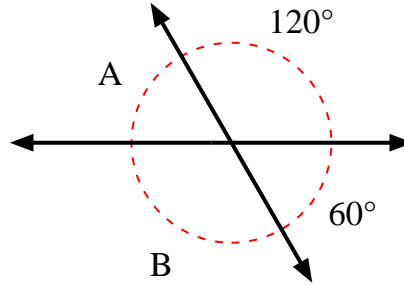

5)

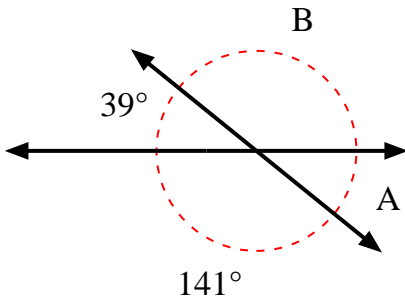

6)

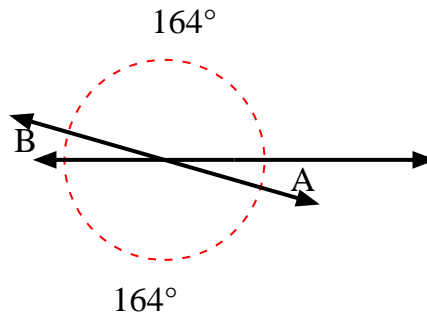

7)

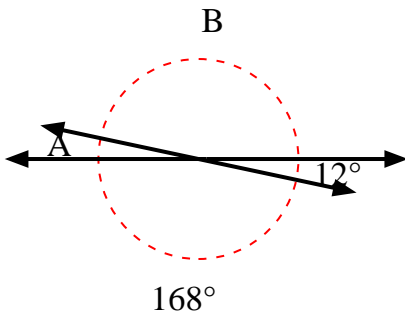

8)

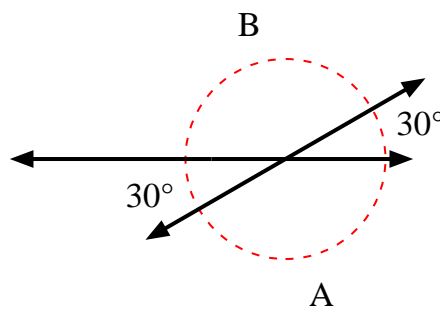

Answers

1. 165°    15°
2. 122°    58°
3. 125°    125°
4. 60°    120°
5. 39°    141°
6. 16°    16°
7. 12°    168°
8. 150°    150°